



JH CURTAIN TRACK

**PROFESSIONAL HEAVY DUTY
TRACK & ACCESSORIES**

Technical Specification Sheet

DESCRIPTION

The Jands JH heavy duty extruded aluminium curtain track is ideal for use in theatre, cinema, touring and hire applications.

Unlike steel truss style tracks, the Jands JH extruded track is easily curved and does not require welding.

The track is coated with a black anodised finish to enhance its durability and appearance.

FEATURES

- Designed for heavy duty applications
- Aluminium extruded section
- Black anodised matt finish
- Fixing centres up to 2 ~ 2.5m apart
- Can be custom curved
- Designed for heavy stage drapes (e.g. heavy fabric and long drops)
- Wide range of accessories available
- Brackets available for direct fixing to truss, structural members or hanging

OVERALL SPECIFICATIONS

Material	:	Aluminium
Finish	:	Black anodised
Standard length	:	6.5m
Weight	:	1.62 kg/m (10.5 kg per 6.5m standard length)

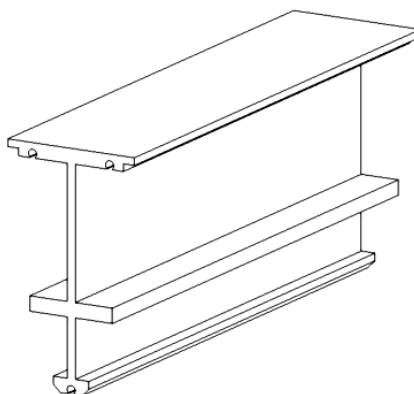

ORDERING INFORMATION

TRACK & FIXINGS

JH CURTAIN TRACK
Part number: MP419L
(6.5m length)

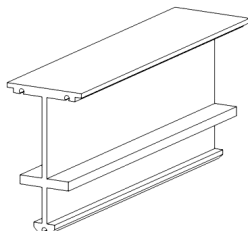

RUNNER
Part number: MP402
Part number: MP402-50 50 per pack

Nylon tyred, ball bearing wheels, black Nylon side plates that attach curtain to track.



90° TRACK BEND 0.6m radius
Part number: MP419-6

90° TRACK BEND 0.8m radius
Part number: MP419-8

JOINING PLATES

Part number: MP411

Black steel complete with bolts, spring washers and nuts for joining JH track. Includes 3 MP483 Track Joining Pins

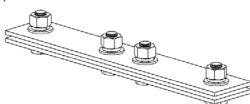

TRACK JOINING PINS

Part Number MP483

Use with JND-MP411 Track Joining Plates for JH Track - 10 per pack

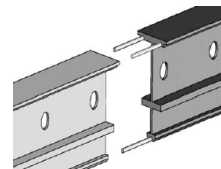

HANGING MOUNTING BRACKET

Part number: MP403A
Hole Dia. 9.5mm

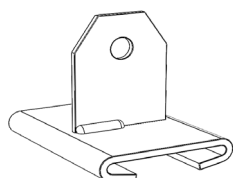

BOLTED HANGING MOUNTING BRACKET

Part number: MP403B
M8 x 65 stud

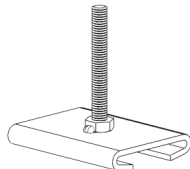

HANGING MOUNTING BRACKET

Part number: MP403C
Hole Dia. 9.5mm

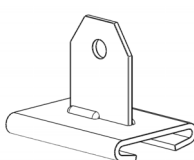

CEILING FIX MOUNTING BRACKET

Part number: MP403D
Hole Dia. 9.5mm

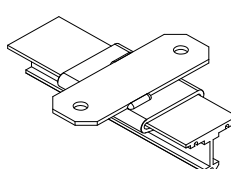

MOUNTING BRACKET FOR "UNISTRUT" CHANNEL

Part number: MP403E

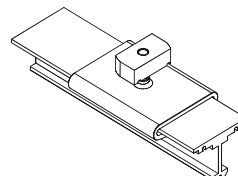

BARREL CLAMP

Part number: MP459
To suit 40NB (48.3mm OD) Tube

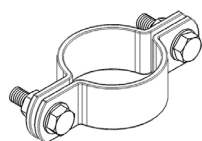

UNIVERSAL MOUNTING BRACKET
Part number: MP470
195mm x 145mm x 6mm

STRAIGHT LEADER

Part number: MP410

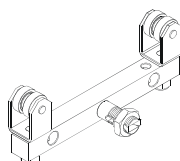

CRANKED LEADER

Part number: MP410A

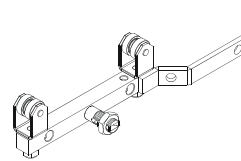

TRACK SPACER PLATES

Part number: MP478

Used to offset JH Track for straight overlap - 2 per pack

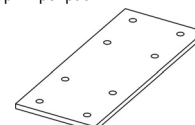

Jands Pty Ltd 40 Kent Road Mascot NSW 2020 Australia
Phone +61 2 9582 0909 Fax +61 2 9582 0999 www.jands.com.au

Specifications subject to change without notice. Manufactured by Jands Pty Ltd ABN 45 001 187 837.
Note: While all due care and attention has been taken in the preparation of this document, Jands Pty Ltd shall not be liable for any inaccuracies or omissions which may occur therein

ARCHITECT & ENGINEER'S SPECIFICATION

The tracking system shall consist of a heavy duty extruded aluminium section, anodised matt black, available in continuous lengths up to 6.5m.

The tracking system shall be capable of spanning up to 2.5m without intermediate support and shall be able to be readily curved to suit custom applications.

A system of accessories to suit the track shall be available including runners, end pulleys, cranked and straight leaders, joining plates, mounting brackets, etc.

The runners will feature black nylon tyres with ball bearing wheels, silent in operation.

The tracking system shall be available with either a hand drawn cord closing system or a motorised winch unit closing system.

The tracking system and accessories shall be the Jands JH professional heavy duty tracking system and accessories.

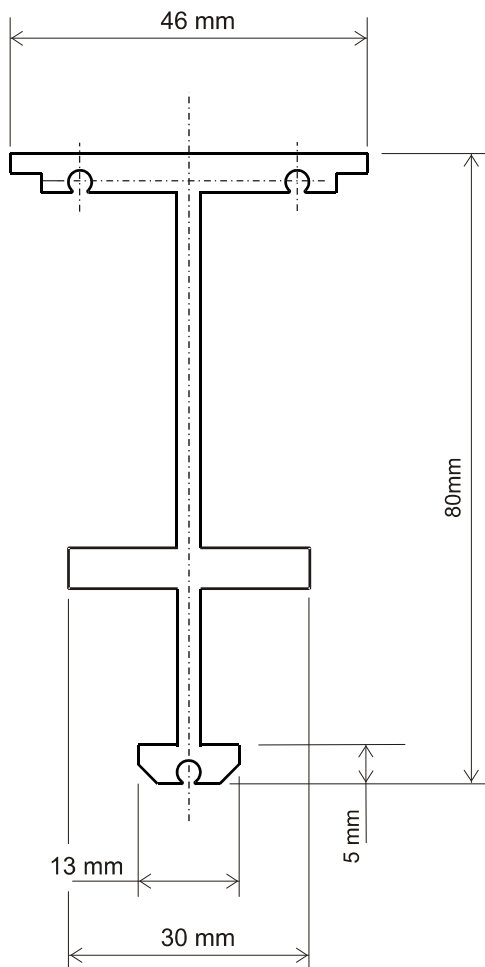

CORD OPERATED AND MOTORISED TRACK SYSTEMS



CENTRE PICK-UP PULLEY
Part number: MP406

Supports hauling line at centre of track

SINGLE END PULLEY PACKER

Part number: MP418

Packs single end pulley away from track for overlap track systems only

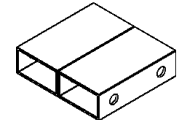

DEAD PULLEY

Part number MP407

For use on curved tracks to guide wire or rope on either the inside or outside of the curve.

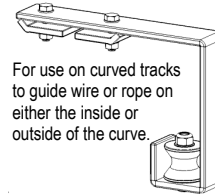

LIVE PULLEY

Part number MP408

For use on curved tracks to guide wire or rope attached to leader on inside of curve only.

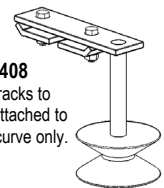

DOUBLE END PULLEY

Part number MP412

For rope/wire return to floor (nylon wheels and black aluminium casting).

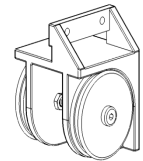

SINGLE END PULLEY

Part number MP413

For rope/wire return to double end pulley (nylon wheels and black aluminium casting).

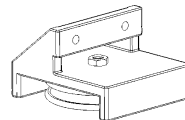

CENTRE HORIZONTAL DIVERSION PULLEY

Part number MP441

For line diversion from JH track

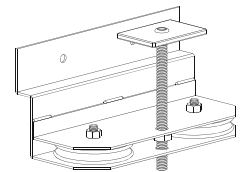

SASH WEIGHT (2.5kg)

Part number: MP471A

Constructed from heavy duty red PVC. Suits draw cord tensioning.

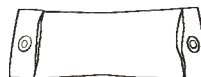

SPRING LOADED FLOOR BLOCK

JND-MP451A

To tension cord draw systems. Attaches to floor under double end pulley

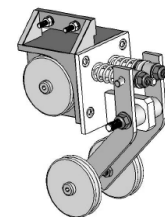

MOTORISED DRUM WINCH

Part Number JND-H100D-S / H100D-SE (with encoder option)

Complete with limit switches (requires JND-HC01V Curtain Controller)

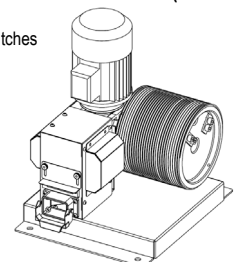

SPRING LOADED DOUBLE END PULLEY

Part number MP412A

Pulley for tensioning steel wire rope on motorised system.